

# MARSYLIA

## Technical Sheet

### Set 1

Sleeping Function 232x128

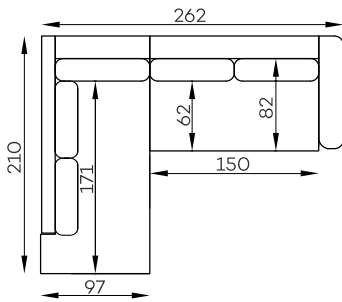

### Collies

Dimensions tolerance of upholstered furniture +/- 4 cm.

Weight	kg net	kg gross	m3	L	S	H	FULL TRUCK 120	FULL TRUCK 90	40HC
collie 1	60	63	0,83	64	85	153	43	33	30
collie 2	53	56	1,2	62	102	190			
collie 3	19	20,5	0,27	42	65	100			

### Construction of the furniture

#### SEAT

**Main structure, frame:**

softwood wood frame

**Additional construction elements:**

chipboard, beech wood frame

**Springs:**

Zig Zag spring (A)

**foam:**

T30 foam

#### LEGS

Black steel h140mm

#### BACKREST

**Main structure :**

board MDF

**Additional construction elements:**

none

**Springs:**

bonell spring 10cm

**foam:**

T30 foam

#### CUSHIONS

**Filled with:**

with a mixed foam granulate  
a mixture of polyurethane foam  
and silicone granulate

Left side

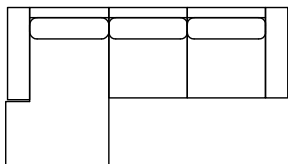

Right side

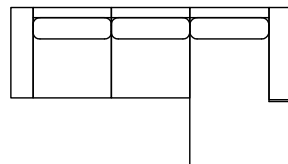

2024-04-09



# MARSYLIA

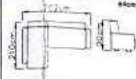
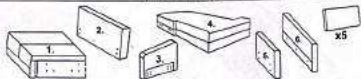

R 8-14  
L 1-7



a. x 2 M8x40 MONO1101	b. x 3 ø50x140 MONO1072	c. x 7 ø56x16 MONO3311	d. x 2 ø50x90 MONO1073	e. x 7 4,5x40 MMED0070
f. x 2 MMED0197	g. x 2 MMED0197	h. x 12 M6x20 MMED0199	i. x 4 M6x25 MMED0205	j. x 4 M8x55 MMED0209
k. x 1 4" MMED0082	l. x 1 5" MMED0085	m. x 4 Ø8 MMED0017	o. x 4 M6x30 MMED0190	p. x 2 MMED0190

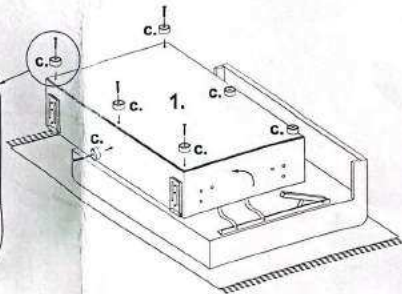
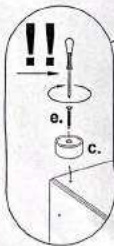

2024-04-09

MARSYLIA

II

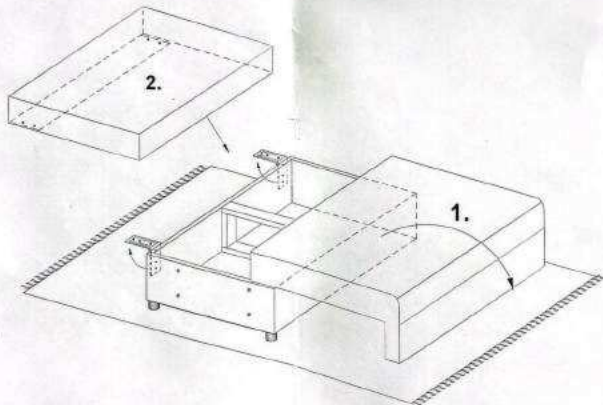
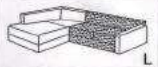

2024-04-09

# MARSYLIA

III

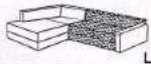

i. x 4  M6x25

k. x 1  "4"

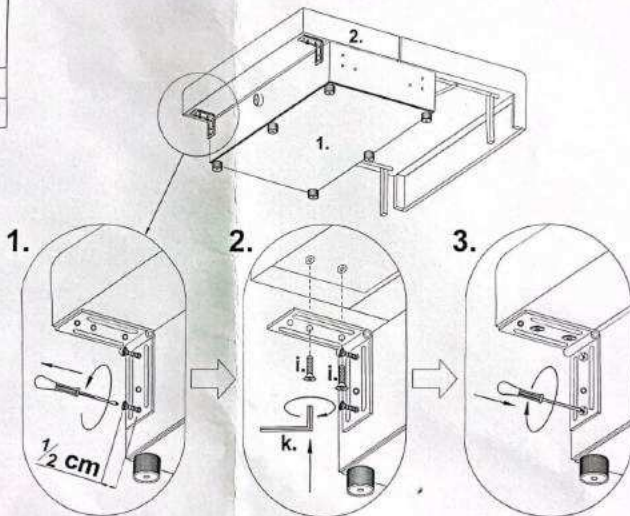

2024-04-09

# MARSYLIA

IV



p. x 2  h=90

h. x 4  M6x20

k. x 1  "d"

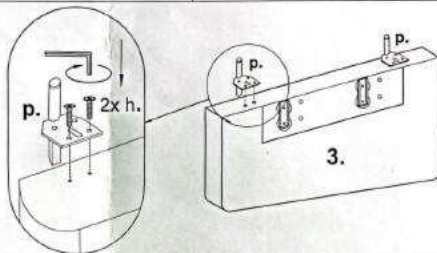

V

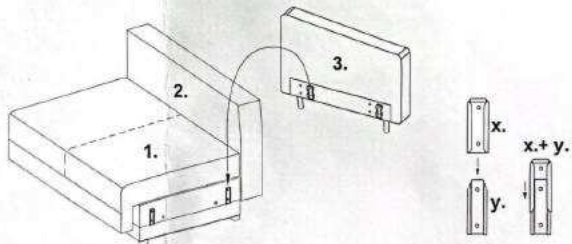

2024-04-09

MARSYLIA

VI

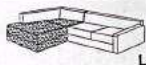

a. x 2 h=140

b. x 3 140

f. x 2

h. x 8 M6x20

k. x 1 "4"

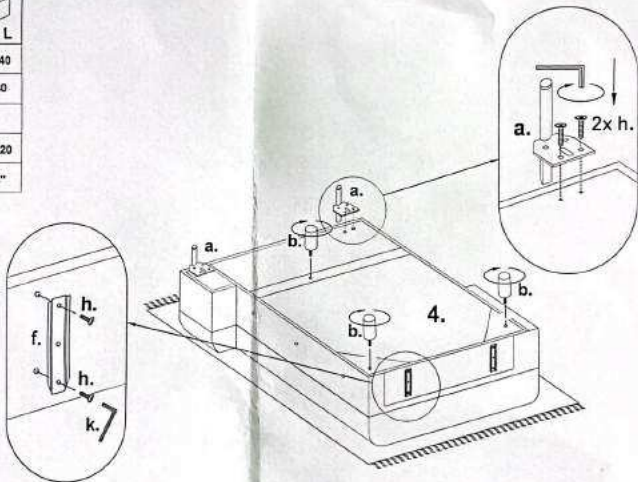

2024-04-09

# MARSYLIA

VII



g. x 2



o. x 4 M6x30



k. x 1 "4"



d. x 2 ø50x90

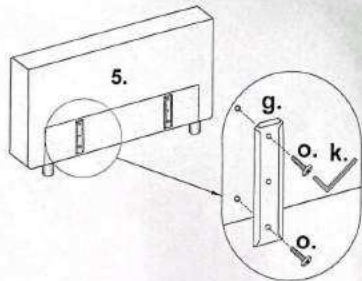
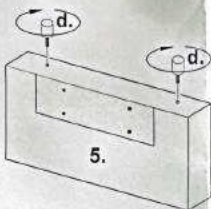

VIII

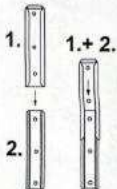
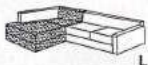

1.

1.+ 2.

2.

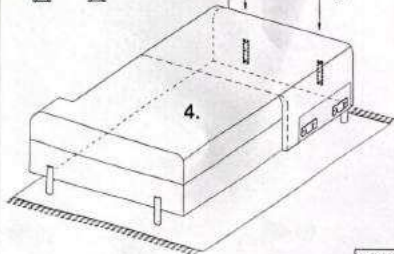

2024-04-09

MARSYLIA

IX

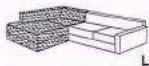

L

j. x 4  M8x55

m. x 4  Ø8

l. x 1  "5"

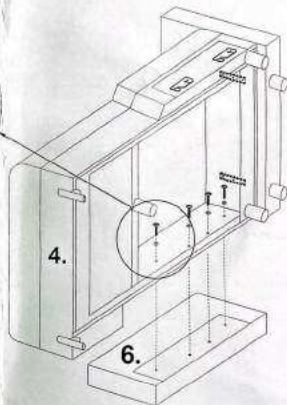
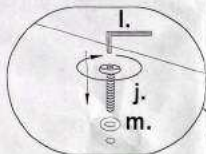



2024-04-09

MARSYLIA

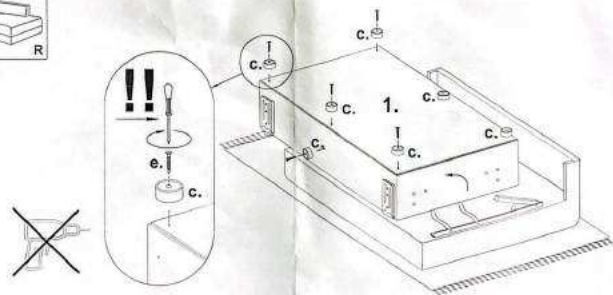

2024-04-09

MARSYLIA

II

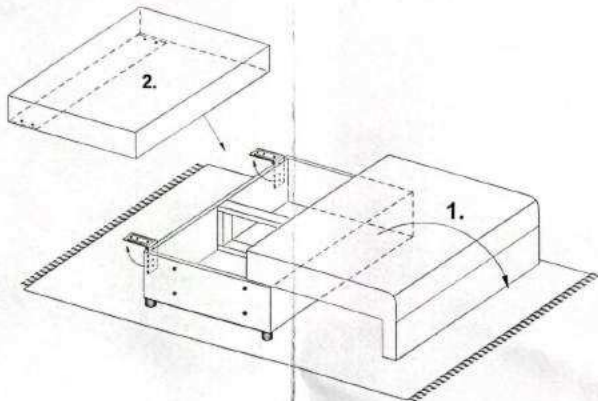

2024-04-09

MARSYLIA

III

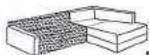

R

i. x 4 M6x25

k. x 1 "4"

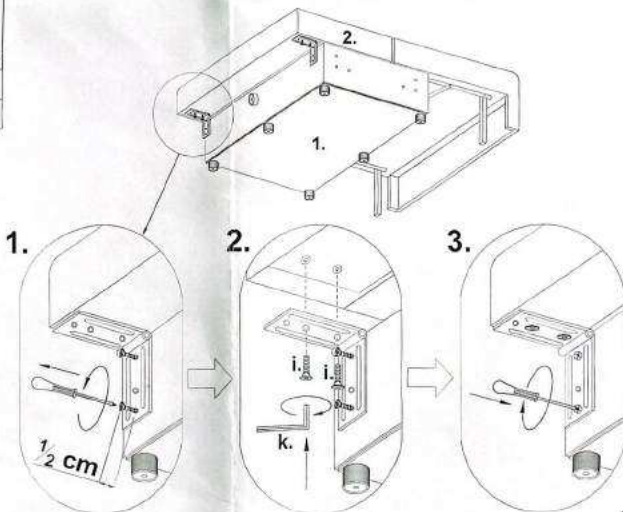

2024-04-09

MARSYLIA

IV



p. x 2  h=90

h. x 4  M6x20

k. x 1  "4"

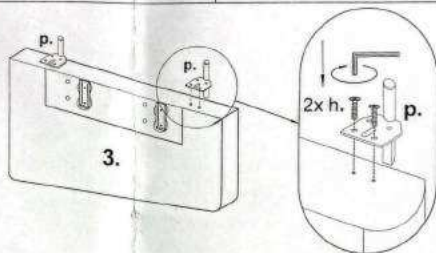

V

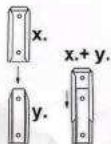
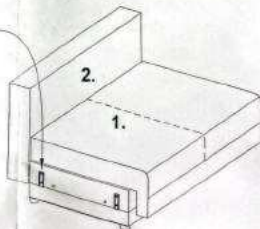
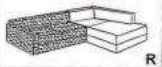

2024-04-09

MARSYLIA

VI

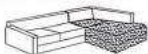

R

a. x 2  h=140

b. x 3  140

f. x 2 

h. x 8  M6x20

k. x 1  "4"

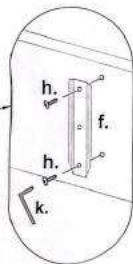
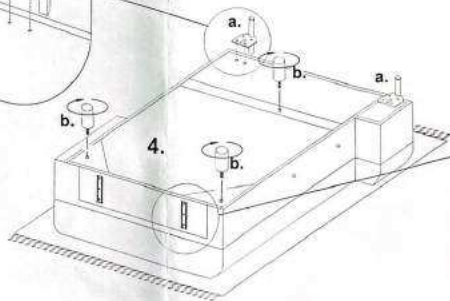
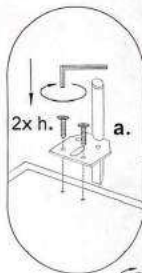

2024-04-09

# MARSYLIA

VII



g. x 2



o. x 4 M6x30



k. x 1 "4"



d. x 2  $\varnothing 50 \times 90$

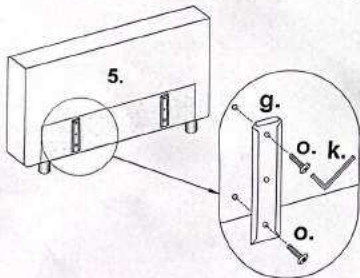
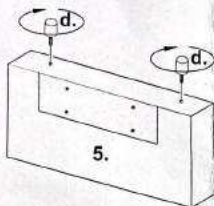

VIII

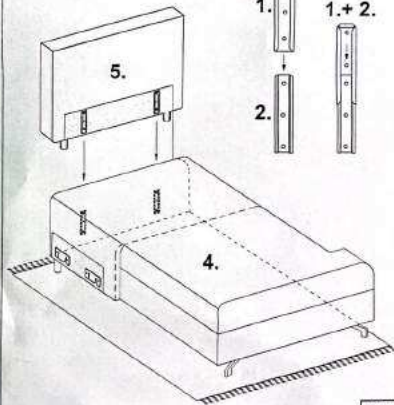
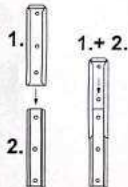
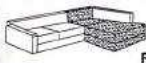

2024-04-09

MARSYLIA

IX



R

j. x 4 MBx55

m. x 4 Ø8

l. x 1 "6"

